

龍頭挖孔尺寸

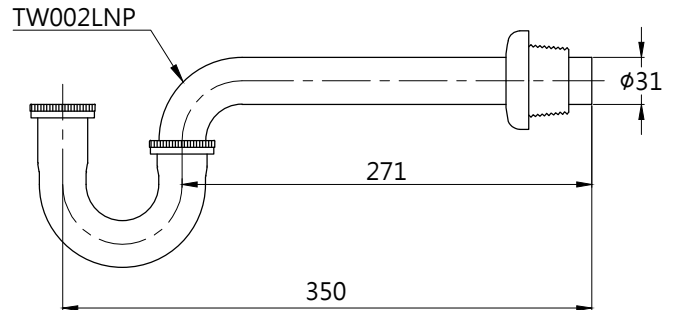

<b>TOTO</b>		單位 mm	比例 1:5	名稱 臉盆用三孔混合龍頭
製圖	檢圖	審核	日期 2017.08.10	品番
備註	版別 03	修改日期 2021.01.25	圖紙 A4	TLG01201P/TW002LNP/PHL300R